

**2547A BARN DOOR HARDWARE TEMPLATE**

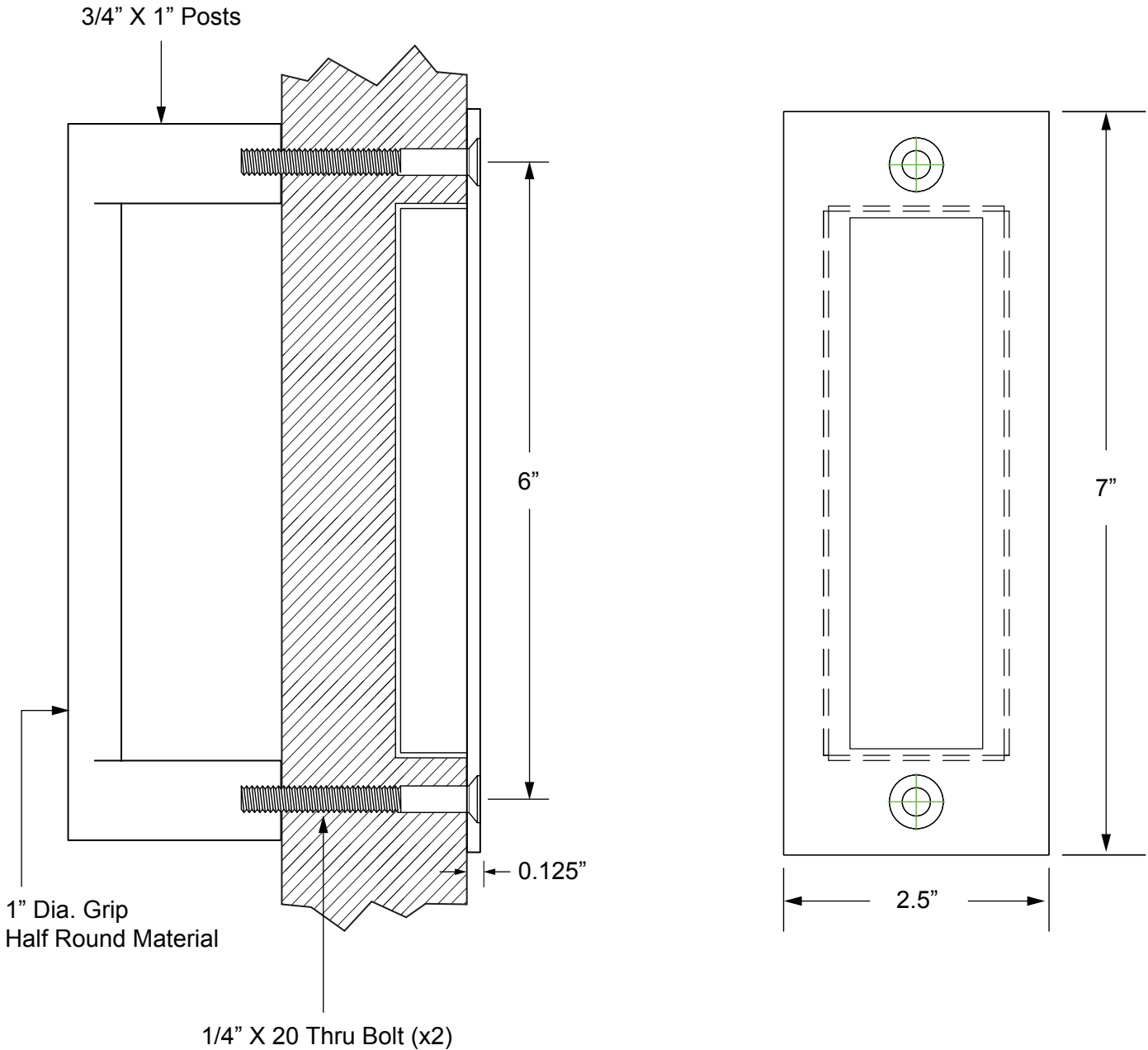

**MORTISE: 2" WIDE X 5-1/4" TALL X 7/8" DEEP X 1/4 Ø**

**GRIP HOLES: 5/16" Ø**

**NOTE:** Due to occasional product changes, please ensure your template is current by checking our website at [www.burnsmfg.com](http://www.burnsmfg.com) or call us at 814-833-7428. Burns Mfg. is not responsible for obsolete template errors.

**Date: 08/18 - Rev. 1**