

605 COAT & HAT HOOK TEMPLATE

Overall Size: 1-1/4" Dia. x 2-3/4" Projection

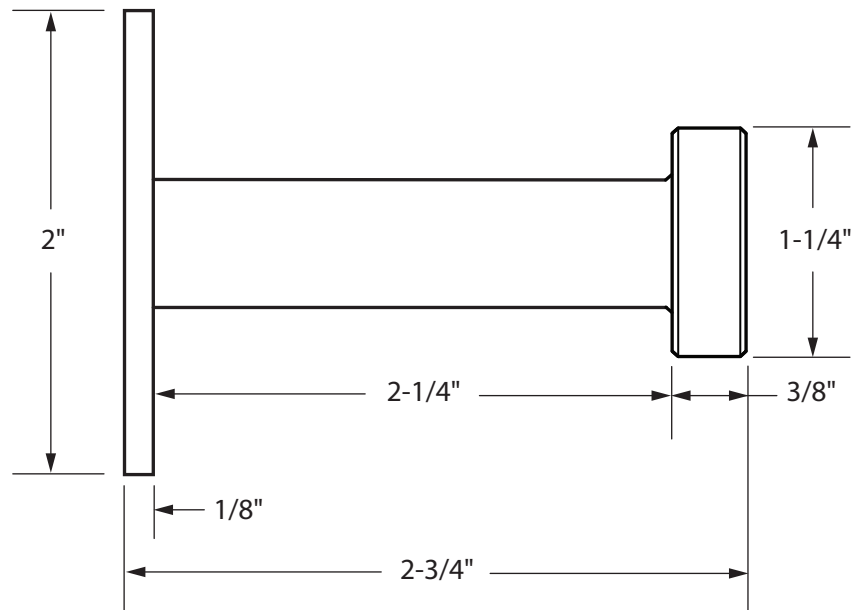

NOTE: Due to occasional product changes, please ensure your template is current by checking our website at www.burnsmfg.com or call us at 814-833-7428. Burns Mfg. is not responsible for obsolete template errors.

Date: 06/16 - Rev. 1