

VP4582 VERTICAL DOOR PULL TEMPLATE

1-1/2" Round Bar, Top & Bottom Round Ends

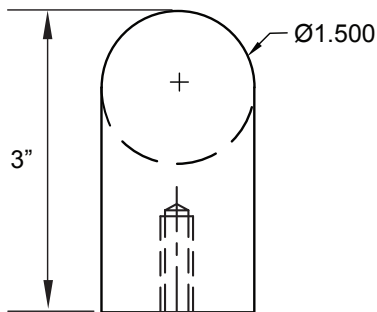
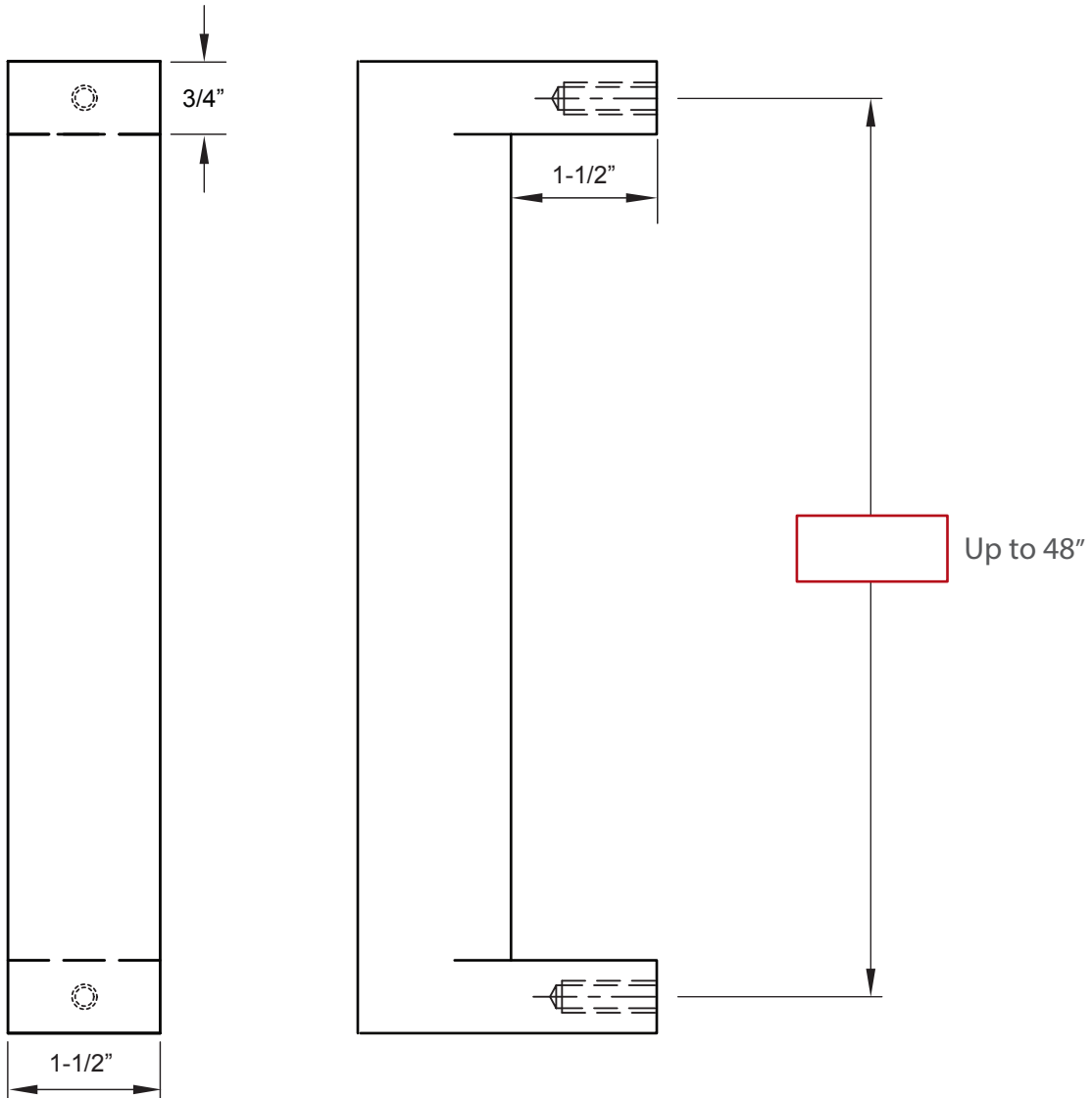

Contact: _____

Customer: _____

PO#: _____ Quantity: _____

Door Type: _____ Door Thickness: _____

Finish: _____ Mounting: _____

Approved By: _____ Date: _____

NOTE: Due to occasional product changes, please ensure your template is current by checking our website at www.burnsmfg.com or call us at 814-833-7428. Burns Mfg. is not responsible for obsolete template errors.

Date: 4/23- Rev. 1